

# High Voltage Power MOSFET

**IXTA3N120**  
**IXTP3N120**  
**IXTH3N120**

N-Channel Enhancement Mode  
Avalanche Rated  
Fast Intrinsic Diode

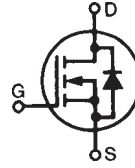

$V_{DSS} = 1200V$   
 $I_{D25} = 3A$   
 $R_{DS(on)} \leq 4.5\Omega$

| Symbol        | Test Conditions  | Maximum Ratings    |            |
|---------------|--|--------------------|------------|
| $V_{DSS}$     | $T_J = 25^\circ C$ to $150^\circ C$                                | 1200               | V          |
| $V_{DGR}$     | $T_J = 25^\circ C$ to $150^\circ C$ , $R_{GS} = 1M\Omega$          | 1200               | V          |
| $V_{GSS}$     | Continuous   | $\pm 20$           | V          |
| $V_{GSM}$     | Transient  | $\pm 30$           | V          |
| $I_{D25}$     | $T_C = 25^\circ C$   | 3                  | A          |
| $I_{DM}$      | $T_C = 25^\circ C$ , Pulse Width Limited by $T_{JM}$               | 12                 | A          |
| $I_A$         | $T_C = 25^\circ C$   | 3                  | A          |
| $E_{AS}$      | $T_C = 25^\circ C$   | 700                | mJ         |
| $dv/dt$       | $I_S \leq I_{DM}$ , $V_{DD} \leq V_{DSS}$ , $T_J \leq 150^\circ C$ | 5                  | V/ns       |
| $P_D$         | $T_C = 25^\circ C$   | 200                | W          |
| $T_J$         |  | -55 ... +150       | $^\circ C$ |
| $T_{JM}$      |  | 150                | $^\circ C$ |
| $T_{stg}$     |  | -55 ... +150       | $^\circ C$ |
| $T_L$         | Maximum Lead Temperature for Soldering                             | 300                | $^\circ C$ |
| $T_{SOLD}$    | 1.6 mm (0.062in.) from Case for 10s                                | 260                | $^\circ C$ |
| $F_C$         | Mounting Force (TO-263)  | 10..65 / 2.2..14.6 | N/lb       |
| $M_d$         | Mounting Torque (TO-247 & TO-220)                                  | 1.13 / 10          | Nm/lb.in   |
| <b>Weight</b> | TO-263   | 2.5                | g          |
|               | TO-220   | 3.0                | g          |
|               | TO-247   | 6.0                | g          |

TO-263 AA (IXTA)



TO-220AB (IXTP)



TO-247 (IXTH)

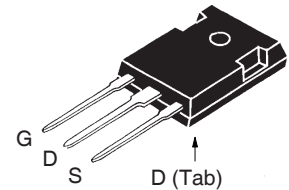

G = Gate      D = Drain  
S = Source    Tab = Drain

## Features

- International Standard Packages
- High Voltage Package
- Fast Intrinsic Diode
- Avalanche Rated
- Molding Epoxies meet UL 94 V-0 Flammability Classification
- High Blocking Voltage

## Advantages

- Easy to Mount
- Space Savings
- High Power Density

## Applications

- High Voltage Power Supplies
- Capacitor Discharge Applications
- Pulse Circuits

| Symbol       | Test Conditions<br>( $T_J = 25^\circ C$ , Unless Otherwise Specified) | Characteristic Values |      |                    |
|--------------|---|-----------------------|------|--------------------|
|              |   | Min.                  | Typ. | Max.               |
| $BV_{DSS}$   | $V_{GS} = 0V$ , $I_D = 1mA$   | 1200                  |      | V                  |
| $V_{GS(th)}$ | $V_{DS} = V_{GS}$ , $I_D = 250\mu A$                                  | 2.5                   |      | 5.0 V              |
| $I_{GSS}$    | $V_{GS} = \pm 20V$ , $V_{DS} = 0V$                                    |                       |      | $\pm 100$ nA       |
| $I_{DSS}$    | $V_{DS} = V_{DSS}$ , $V_{GS} = 0V$<br>$T_J = 125^\circ C$             |                       |      | 25 $\mu A$<br>1 mA |
| $R_{DS(on)}$ | $V_{GS} = 10V$ , $I_D = 0.5 \cdot I_{D25}$ , Note 1                   |                       |      | 4.5 $\Omega$       |

| Symbol       | Test Conditions<br>( $T_J = 25^\circ\text{C}$ , Unless Otherwise Specified)  | Characteristic Values |      |                         |
|--------------|--|-----------------------|------|-------------------------|
|              |  | Min.                  | Typ. | Max                     |
| $g_{fs}$     | $V_{DS} = 20\text{V}$ , $I_D = 0.5 \cdot I_{D25}$ , Note 1   | 1.5                   | 2.6  | S                       |
| $C_{iss}$    | $V_{GS} = 0\text{V}$ , $V_{DS} = 25\text{V}$ , $f = 1\text{MHz}$   |                       | 1100 | 1350 pF                 |
| $C_{oss}$    |  |                       | 110  | 135 pF                  |
| $C_{rss}$    |  |                       | 40   | 60 pF                   |
| $t_{d(on)}$  | <b>Resistive Switching Times</b><br>$V_{GS} = 10\text{V}$ , $V_{DS} = 0.5 \cdot V_{DSS}$ , $I_D = 0.5 \cdot I_{D25}$<br>$R_G = 4.7\Omega$ (External) |                       | 17   | ns                      |
| $t_r$        |  |                       | 15   | ns                      |
| $t_{d(off)}$ |  |                       | 32   | ns                      |
| $t_f$        |  |                       | 18   | ns                      |
| $Q_{g(on)}$  | $V_{GS} = 10\text{V}$ , $V_{DS} = 0.5 \cdot V_{DSS}$ , $I_D = 0.5 \cdot I_{D25}$   |                       | 42   | nC                      |
| $Q_{gs}$     |  |                       | 8    | nC                      |
| $Q_{gd}$     |  |                       | 21   | nC                      |
| $R_{thJC}$   |  |                       |      | 0.62 $^\circ\text{C/W}$ |
| $R_{thCS}$   | TO-220   |                       | 0.50 | $^\circ\text{C/W}$      |
| $R_{thCS}$   | TO-247   |                       | 0.21 | $^\circ\text{C/W}$      |

### Source-Drain Diode

| Symbol   | Test Conditions<br>( $T_J = 25^\circ\text{C}$ , Unless Otherwise Specified)                          | Characteristic Values |      |       |
|----------|--|-----------------------|------|-------|
|          |  | Min.                  | Typ. | Max   |
| $I_S$    | $V_{GS} = 0\text{V}$   |                       |      | 3 A   |
| $I_{SM}$ | Repetitive, Pulse Width Limited by $T_{JM}$  |                       |      | 12 A  |
| $V_{SD}$ | $I_F = I_S$ , $V_{GS} = 0\text{V}$ , Note 1  |                       |      | 1.5 V |
| $t_{rr}$ | $I_F = 3\text{A}$ , $V_{GS} = 0\text{V}$ , $-di/dt = 100\text{A}/\mu\text{s}$<br>$V_R = 100\text{V}$ |                       | 700  | ns    |

Note 1: Pulse test,  $t \leq 300\mu\text{s}$ , duty cycle,  $d \leq 2\%$ .

### TO-263 Outline

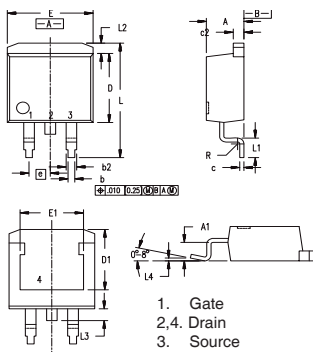

| Dim. | Millimeter |       | Inches |      |
|------|------------|-------|--------|------|
|      | Min.       | Max.  | Min.   | Max. |
| A    | 4.06       | 4.83  | .160   | .190 |
| b    | 0.51       | 0.99  | .020   | .039 |
| b2   | 1.14       | 1.40  | .045   | .055 |
| c    | 0.40       | 0.74  | .016   | .029 |
| c2   | 1.14       | 1.40  | .045   | .055 |
| D    | 8.64       | 9.65  | .340   | .380 |
| D1   | 8.00       | 8.89  | .280   | .320 |
| E    | 9.65       | 10.41 | .380   | .405 |
| E1   | 6.22       | 8.13  | .270   | .320 |
| e    | 2.54       | BSC   | .100   | BSC  |
| L    | 14.61      | 15.88 | .575   | .625 |
| L1   | 2.29       | 2.79  | .090   | .110 |
| L2   | 1.02       | 1.40  | .040   | .055 |
| L3   | 1.27       | 1.78  | .050   | .070 |
| L4   | 0          | 0.13  | 0      | .005 |

### TO-220 Outline

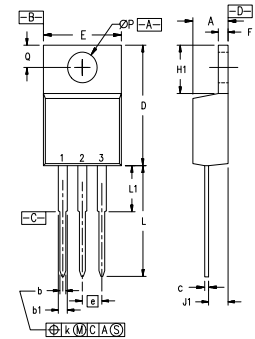

Pins: 1 - Gate  
2 - Drain  
3 - Source

| SYM | INCHES   |      | MILLIMETERS |       |
|-----|----------|------|-------------|-------|
|     | MIN      | MAX  | MIN         | MAX   |
| A   | .170     | .190 | 4.32        | 4.83  |
| b   | .025     | .040 | 0.64        | 1.02  |
| b1  | .045     | .065 | 1.15        | 1.65  |
| c   | .014     | .022 | 0.35        | 0.56  |
| D   | .580     | .630 | 14.73       | 16.00 |
| E   | .390     | .420 | 9.91        | 10.66 |
| e   | .100 BSC |      | 2.54 BSC    |       |
| F   | .045     | .055 | 1.14        | 1.40  |
| H1  | .230     | .270 | 5.85        | 6.85  |
| J1  | .090     | .110 | 2.29        | 2.79  |
| k   | 0        | .015 | 0           | 0.38  |
| L   | .500     | .550 | 12.70       | 13.97 |
| L1  | .110     | .230 | 2.79        | 5.84  |
| ØP  | .139     | .161 | 3.53        | 4.08  |
| Q   | .100     | .125 | 2.54        | 3.18  |

### TO-247 Outline

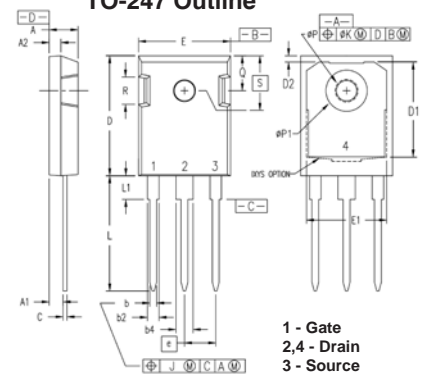

1 - Gate  
2,4 - Drain  
3 - Source

| Dim. | Millimeter |       | Inches    |       |
|------|------------|-------|-----------|-------|
|      | min        | max   | min       | max   |
| A    | 4.70       | 5.30  | 0.185     | 0.209 |
| A1   | 2.21       | 2.59  | 0.087     | 0.102 |
| A2   | 1.50       | 2.49  | 0.059     | 0.098 |
| b    | 0.99       | 1.40  | 0.039     | 0.055 |
| b2   | 1.65       | 2.39  | 0.065     | 0.094 |
| b4   | 2.59       | 3.43  | 0.102     | 0.135 |
| c    | 0.38       | 0.89  | 0.015     | 0.035 |
| D    | 20.79      | 21.45 | 0.819     | 0.845 |
| D1   | 13.07      | -     | 0.515     | -     |
| D2   | 0.51       | 1.35  | 0.020     | 0.053 |
| E    | 15.48      | 16.24 | 0.610     | 0.640 |
| E1   | 13.45      | -     | 0.53      | -     |
| E2   | 4.31       | 5.48  | 0.170     | 0.216 |
| e    | 5.45 BSC   |       | 0.215 BSC |       |
| L    | 19.80      | 20.30 | 0.078     | 0.800 |
| L1   | -          | 4.49  | -         | 0.177 |
| Ø P1 | 3.55       | 3.65  | 0.140     | 0.144 |
| Ø P1 | -          | 7.39  | -         | 0.290 |
| Q    | 5.38       | 6.19  | 0.212     | 0.244 |
| S    | 6.14 BSC   |       | 0.242 BSC |       |

IXYS Reserves the Right to Change Limits, Test Conditions, and Dimensions.

|  |           |           |           |           |             |             |             |             |             |             |
|--|-----------|-----------|-----------|-----------|-------------|-------------|-------------|-------------|-------------|-------------|
| IXYS MOSFETs and IGBTs are covered by one or more of the following U.S. patents: | 4,835,592 | 4,931,844 | 5,049,961 | 5,237,481 | 6,162,665   | 6,404,065B1 | 6,683,344   | 6,727,585   | 7,005,734B2 | 7,157,338B2 |
|  | 4,860,072 | 5,017,508 | 5,063,307 | 5,381,025 | 6,259,123B1 | 6,534,343   | 6,710,405B2 | 6,759,692   | 7,063,975B2 |             |
|  | 4,881,106 | 5,034,796 | 5,187,117 | 5,486,715 | 6,306,728B1 | 6,583,505   | 6,710,463   | 6,771,478B2 | 7,071,537   |             |

Fig. 1. Output Characteristics @  $T_J = 25^\circ\text{C}$

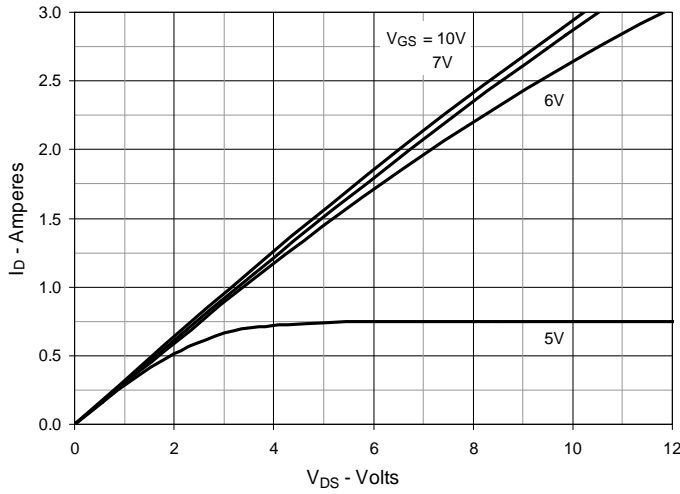

Fig. 2. Extended Output Characteristics @  $T_J = 25^\circ\text{C}$

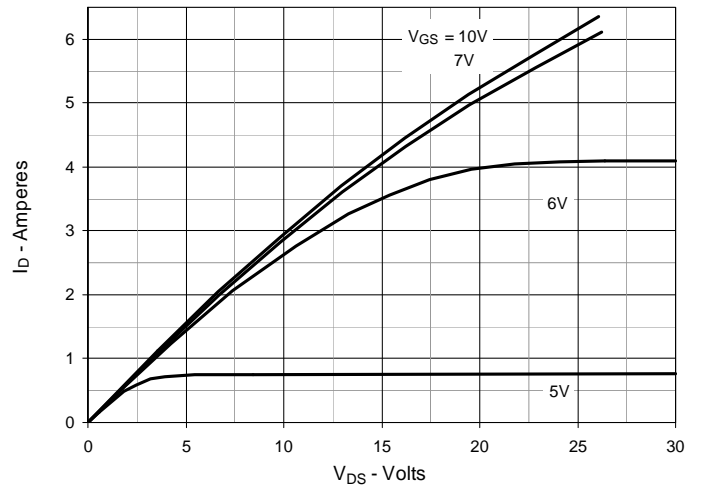

Fig. 3. Output Characteristics @  $T_J = 125^\circ\text{C}$

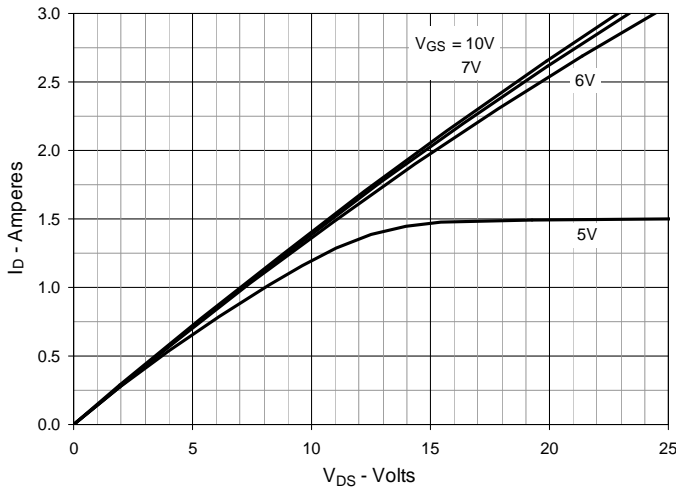

Fig. 4.  $R_{DS(on)}$  Normalized to  $I_D = 1.5\text{A}$  Value vs. Junction Temperature

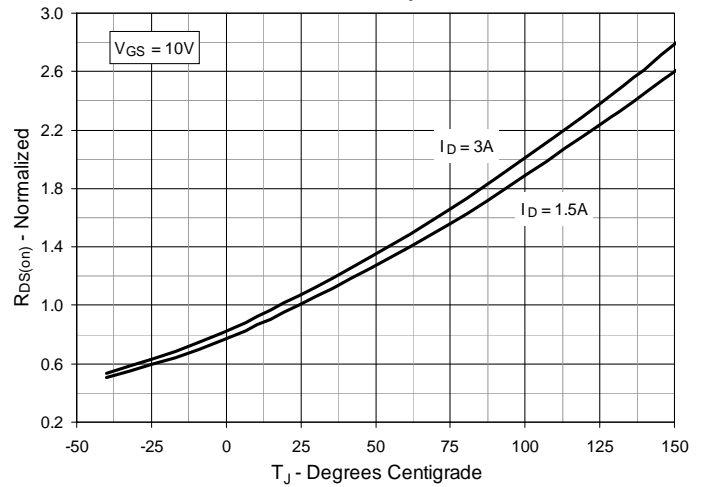

Fig. 5.  $R_{DS(on)}$  Normalized to  $I_D = 1.5\text{A}$  Value vs. Drain Current

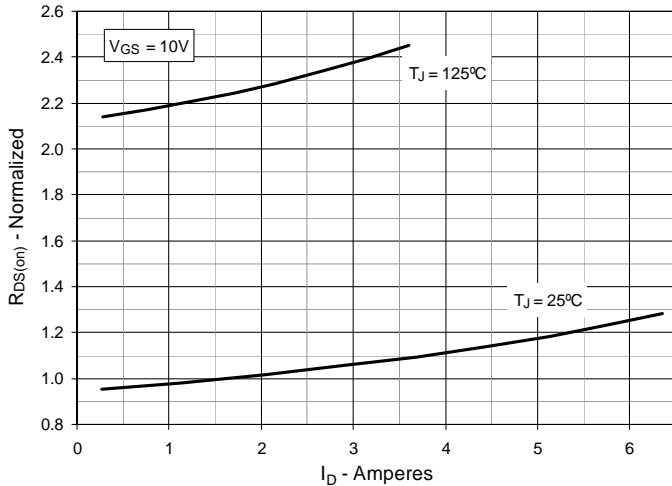

Fig. 6. Maximum Drain Current vs. Case Temperature

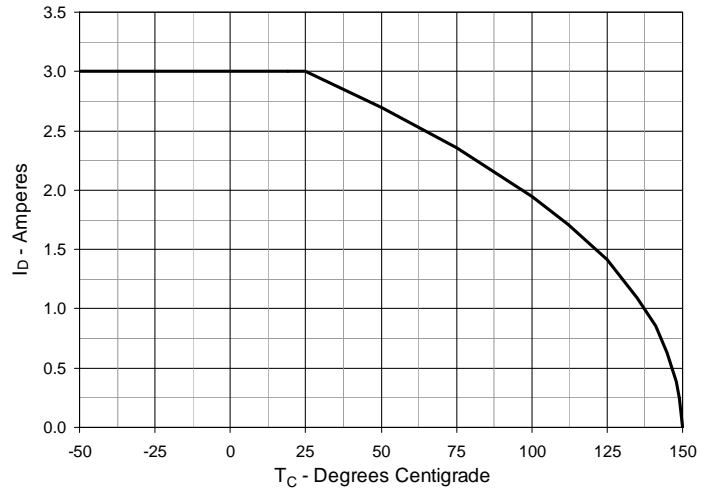

Fig. 7. Input Admittance

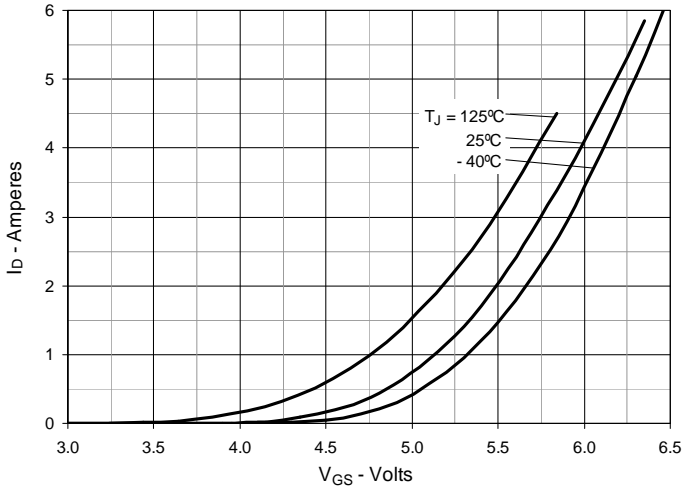

Fig. 8. Transconductance

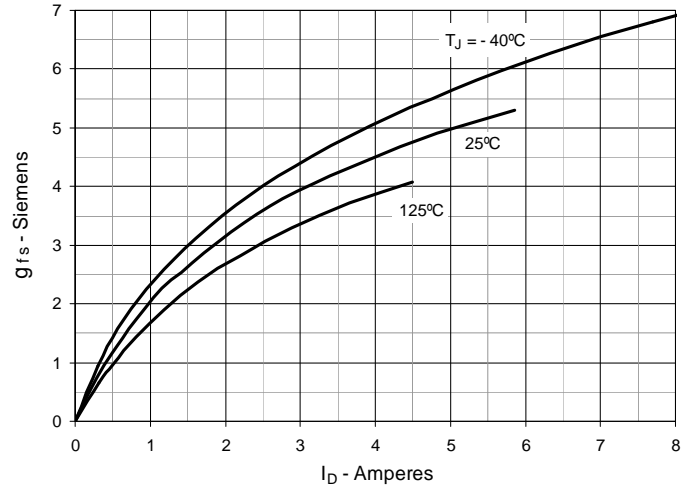

Fig. 9. Forward Voltage Drop of Intrinsic Diode

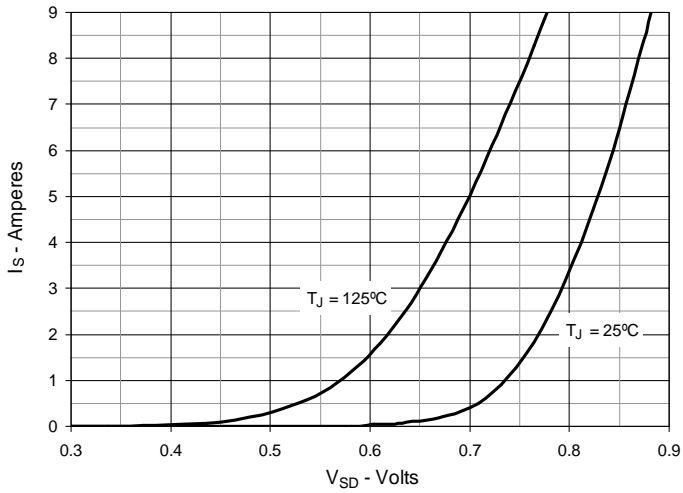

Fig. 10. Gate Charge

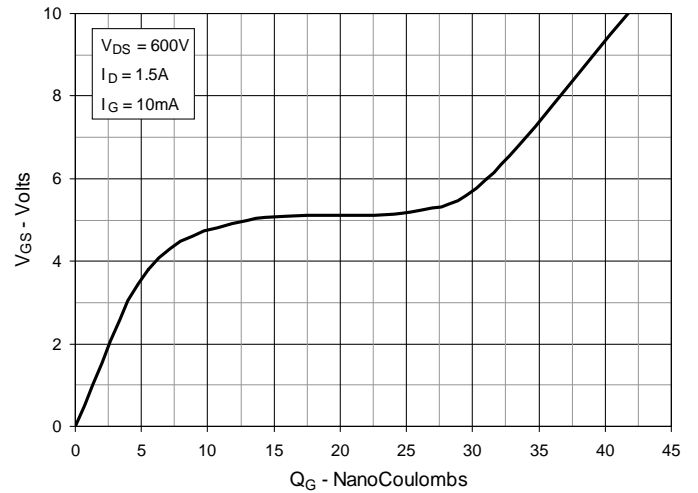

Fig. 11. Capacitance

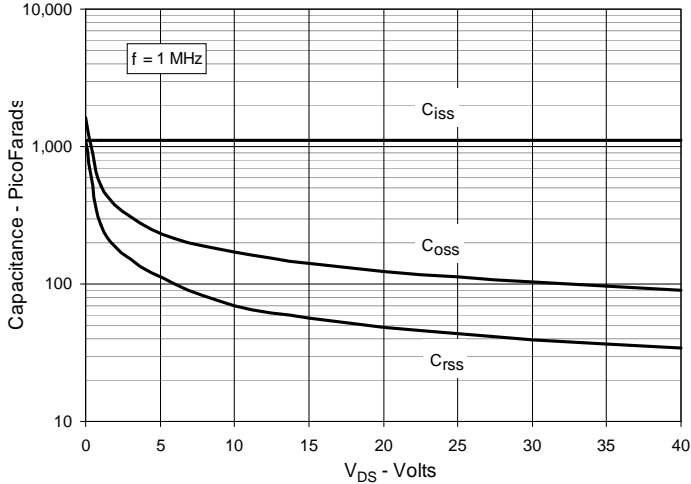

Fig. 12. Forward-Bias Safe Operating Area

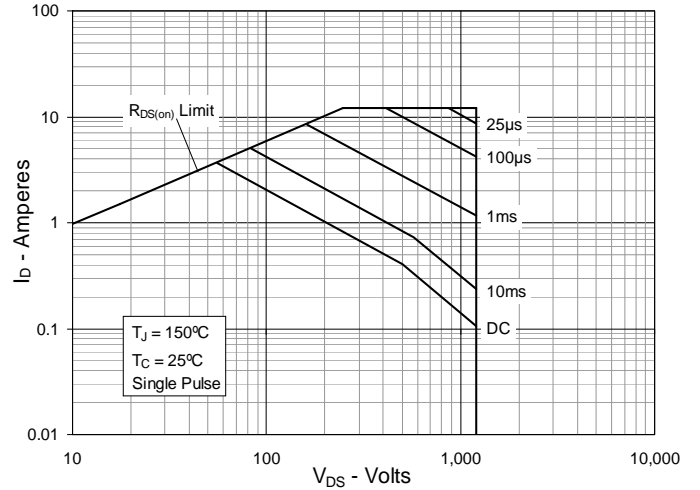
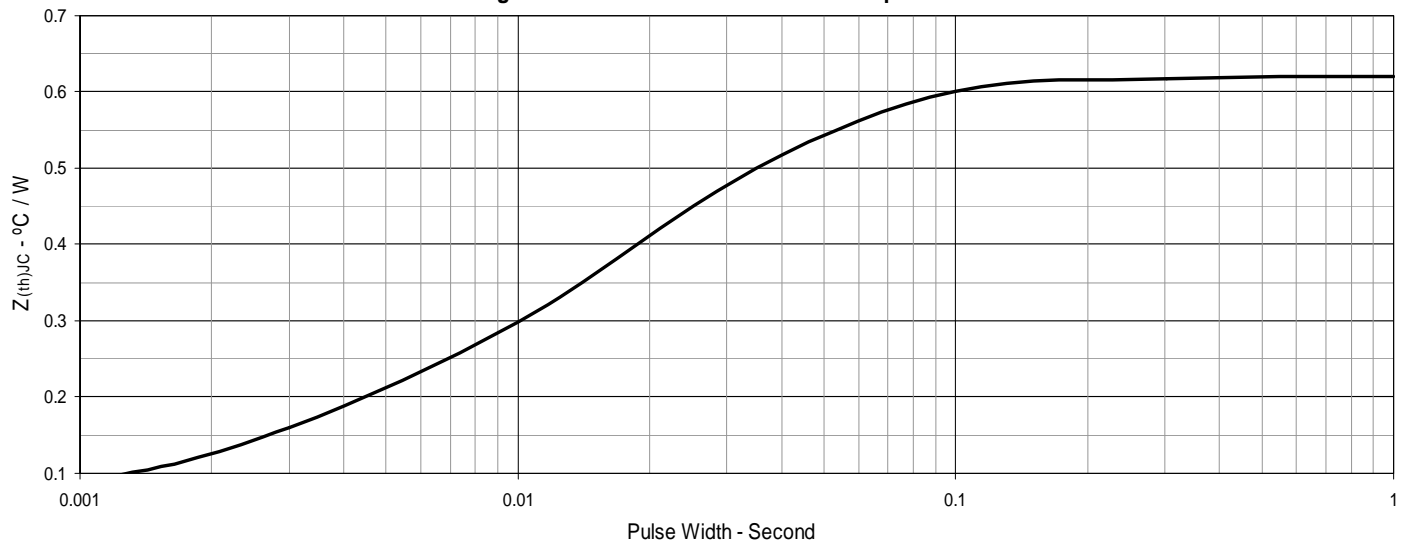

Fig. 13. Maximum Transient Thermal Impedance





---

Disclaimer Notice - Information furnished is believed to be accurate and reliable. However, users should independently evaluate the suitability of and test each product selected for their own applications. Littelfuse products are not designed for, and may not be used in, all applications. Read complete Disclaimer Notice at [www.littelfuse.com/disclaimer-electronics](http://www.littelfuse.com/disclaimer-electronics).